

# GV- BLFC5800 AI 5MP H.265 Super Low Lux WDR Pro Full Color Warm LED Bullet IP Camera



- AI deep learning: Smart Perimeter Protection & Classification (Human, Vehicle)
- 1/2.7" progressive scan CMOS sensor
- Min. illumination at 0.001 lux
- Triple streams from H.265, H.264 or MJPEG
- Up to 30 fps at 2880 x 1620
- Full color smart warm LEDs distance up to 30 m (100 ft)
- Vandal Resistance (IK10 for metal casing)
- Ingress protection (IP67)
- Built-in micro SD card slot (SD / SDHC / SDXC / UHS-I, Class 10) for local storage
- Two-way audio
- DC 12V / PoE (IEEE 802.3af)
- Wide Dynamic Range Pro (WDR Pro)
- AI analytics (Cross Line, Intrusion, Enter Area, Leave Area, Face Detection, People Flow Counting, Crowd Density Monitoring)
- Defog
- 3D noise reduction
- Motion detection
- Text overlay
- Privacy mask
- Tampering Alarm
- 12 languages supported
- ONVIF (Profile G, S, T) conformant

## Introduction

GV-BLFC5800 is an outdoor, network camera with built-in full color smart warm LEDs for accuracy enhancement of critical elements for day and night surveillance. The camera supports H.265 video codec to achieve better compression ratio while maintaining high quality pictures at reduced network bandwidths. The camera adheres to IK10 and IP67 standards, and can be powered through PoE.

Empowered by deep learning algorithms, AI technology distinguishes human and vehicles from other moving objects. Integrated with GeoVision Video Management Software (VMS), it supports AI perimeter protection, real time alert, events playback and more.

## Deep Learning Function

### Face Detection



### AI Perimeter Protection (Intrusion, Crossing Line Entering Area, Leaving Area)

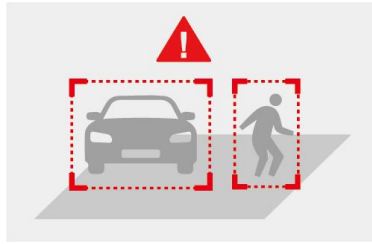

### People Counting

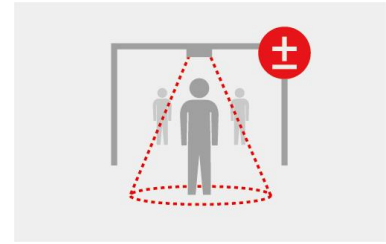

**Note:** The integration of AI events of the camera to GV-VMS is coming soon.

## Dimensions

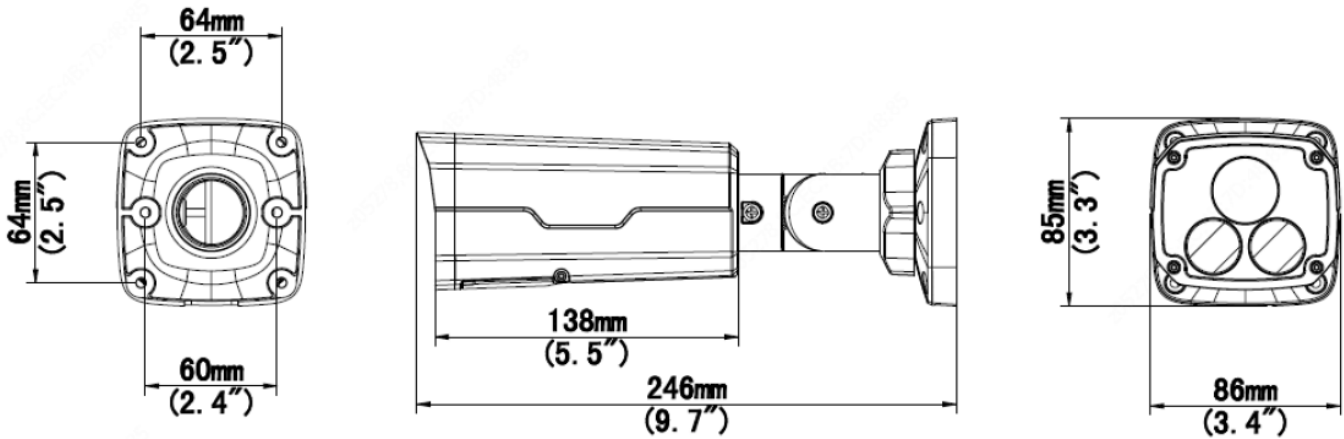

## Specifications

Camera		
Image Sensor	1/2.7" progressive scan CMOS	
Picture Elements	2880 (H) x 1620 (V)	
Minimum Illumination	Color	0.001 Lux (F1.0, AGC ON)
Shutter Speed	Auto / Manual (1 ~ 1/100000 sec)	
White Balance	Automatic, Manual	
Gain Control	Automatic, Manual	
S/N Ratio	56 dB	
WDR Pro	Yes	
Dynamic Range	120 dB	
Lens		
Megapixel	5 MP	
Day / Night	Color	
Lens Type	Fixed	
Focal Length	4mm	
Maximum Aperture	F/1.0	
Mount	M12	
Horizontal FOV	80.2°	
Operation	Focus	Fixed
	Zoom	Fixed
	Iris	Fixed

Smart Illumination	LED Quantity	Warm LEDs
	Max. LED Distance	30 m (100 ft)
<b>Operation</b>		
Video Compression		H.265, H.264, MJPEG
Video Streaming		Triple streams
Video Resolution	Main Stream	2880 x 1620 (default), 2560 x 1440, 2304 x 1296, 1920 x 1080, 1280 x 720
	Sub Stream	1280 x 720, 720 x 576, 704 x 288, 640 x 480, 640 x 360 (Default), 352 x 288
	Third Stream (Closed by Default)	640 x 360, 352 x 288
Frame Rate		30 fps at 2880 x 1620, 30 fps at 2560 x 1440, 30 fps at 2304 x 1296, 30 fps at 1920 x 1080 (60 / 50 Hz) * The frame rate and performance may vary depending on the number of connections and data bitrates (different scenes).
Video Analytics		Motion Detection, Tampering Alarm, Audio Detection. *Tampering alarm and audio detection are only accessible through the camera's Web interface, which can be used to trigger alerts such as e-mail and FTP
Image Setting		Brightness, Contrast, Saturation, Sharpness, Flicker-less, 3D Noise Reduction, Image Orientation (Flip, Mirror, 0°, 90°, 180°, 270°-including Corridor format).
Audio Compression		G.711
Audio Support		Two-way Audio (external microphone and speaker required)
Digital I/O	Input	1 Input, dry contact, NO / NC
	Output	1 Relay Output (1A 30V DC / 0.3A 125V AC)
<b>Network</b>		
Interface		10/100 Ethernet
Protocol		802.1x, ARP, DHCP, DDNS, DNS, DynDNS, FTP, HTTP, HTTPS, ICMP, IGMP, IPv4, NTP, PPPoE, QoS, RTCP, RTP, RTSP, SMTP, SNMP, TCP, UDP, UPnP, ONVIF (Profile G, S, T),
<b>Deep Learning Function</b>		
AI Analytics		Intrusion, Crossing Line, Entering Area, Leaving Area (Human & Vehicle classification), Face Detection, People Flow Counting, Crowd Density Monitoring
<b>Mechanical</b>		
Camera Angle Adjustment	Pan	0 ~ 360°
	Tilt	0 ~ 90°
	Rotate	0 ~ 360°
Connectors	Power	DC Jack, PoE
	Ethernet	RJ-45
	Audio	1 in (Audio In Wire); 1 out (Audio Out Wire) *The Audio In port only supports microphones with power supply
	Digital I/O	4-pin terminal block pitch 3.5 mm (0.14")
	Local Storage	Micro SD card slot (SD / SDHC / SDXC / UHS-I, Class 10) * UHS-II card type is not supported.
<b>General</b>		
Operating Temperature		-30°C ~ 60°C (-22°F ~ 140°F)
Humidity		0 ~ 95% (no condensation)
Power Source		12 V DC / PoE (IEEE 802.3af)
Max. Power Consumption		9.0W
Dimensions		246 x 86 x 85 mm (9.7" x 3.4" x 3.3")
Weight		0.92 kg (2.02 lb)
Ingress Protection		IP67
Vandal Resistance		IK10 for metal casing
Regulatory		FCC, CE, RoHS compliant
<b>Web Interface</b>		
Installation Management		Web-based configuration
Maintenance		Firmware upgrade through Web Browser or Utility
Access from Web Browser		Live View, Video Recording, Change Video Quality, Bandwidth Control, Image Snapshot, Text Overlay, Image Masking
Language		Czech, English, French, German, Hungarian, Italian, Japanese, Polish, Portuguese, Russian, Spanish, Traditional Chinese

Software Application	
Software Supported	GV-VMS (V17.4.3 / V18.2.1), GV-DVR / NVR (V8.9.1), GV-Control Center (V3.8.0 / V4.0.1), GV-Recording Server / Video Gateway (V2.0.0), GV-Edge Recording Manager Windows Version (V2.0.0), GV-Redundant / Failover Server (V1.2.0), GV-AI Guard (V1.0.0), GV-Mobile Server (V1.5.1)
Smart Device Access	GV-Eye for iOS and Android
Live Viewing	Browser (IE, Edge, Chrome), Mobile App





**Note:**

1. It is required to apply patch files to some of the supported software.
2. Do not use clothes or any ordinary material to clean the camera cover since they may result in scratches.
3. Specifications are subject to change without notice.

**Packing List**

- |                          |                          |
|--------------------------|--------------------------|
| 1. BLFC5800 Bullet       | 4. Drill Template Paster |
| 2. Waterproof Rubber Set | 5. Download Guide        |
| 3. Screw Kit             |                          |

**Accessories**

Model No.	Name		Details
GV-Mount300-2	Convex Corner Mount		Dimensions: 137 x 233 x 160 mm (5.4" x 9.17" x 6.3") Weight: 1.65 kg (3.64 lb)
GV-Mount310-2	Concave Corner Mount		Dimensions: 111.2 x 369.9 x 210 mm (2.6" x 11.4" x 6.6") Weight: 1.65 kg (3.64 lb)
GV-Mount420 (must be used with GV-Mount503)	Pole Mount Bracket		Dimensions: Ø 120 x 120 x 53.4 mm (Ø 4.7" x 4.7" x 2.1") Weight: 0.45 kg (0.99 lb) Steel Strap Diameter: Ø 67 ~ 127 mm (Ø 2.6" ~ 5")
GV-Mount503	Wall Mount Bracket		Dimensions: 125 x 125 x 55 mm (4.9" x 4.9" x 2.2") Weight: 0.74 kg (1.63 lb)
GV-PA191	Power over Ethernet (PoE) Adapter		GV-PA191 is a Power over Ethernet (PoE) adapter designed to provide power to the IP device through a single Ethernet cable.
GV-POE Switch			GV-POE Switch is designed to provide power along with network connection for IP devices. The GV-POE Switch is available in various models with different numbers and types of ports.
Power Adapter			Contact our sales representatives for the countries and areas supported.